

# 11 Abrasives

**11.3** Grinding wheels

**11.30** Diamond paste and stones for cleaning

**11.32** Accessories for wheels

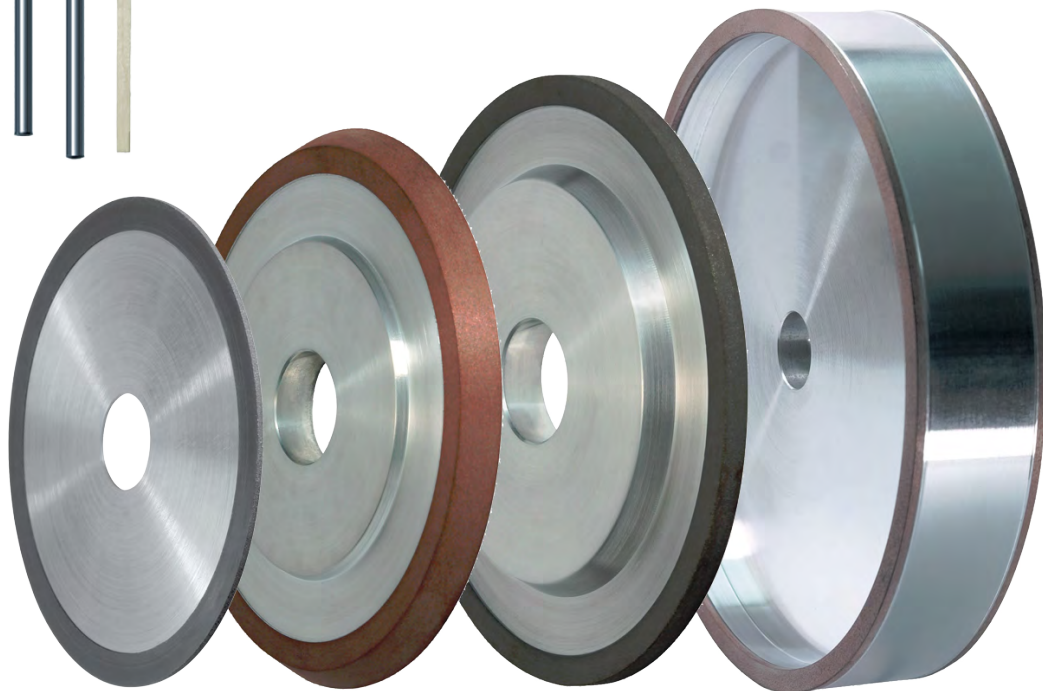



# Grinding wheels

## Bond description



### Technical informations

Unirock's bonds are created and developed in Biel, centre of the compagny. A high level technical mastery and an innovative research spirit characterize our bonds elaborated for you by our team of experts.

Item No	Bonds
F1	Hybrid deep grindind (Wet grinding)
F11	Hybrid universal hard
S1	Hybrid universal soft
PSE	Universal grift
PSEN	Fine grift
PSER	Resin-ceramic for diamant pins wheels
GGE	Universel for rough grift
GGG	resin metal Universal
RLG/PSE	For disc
MD03C	Bronze bond for profil
PSE/2KS	For small grift siz
PSQ	Universal Hard
PSQN	Universal Hard for 1A8
GGX	Resin metal hard (wet grinding)
GGSP	Resin metal very hard D46-D151 (wet grinding)
JMK1	Universal very good cut 46-251 CBN
JMK3	Resin metal very hard D10-D40 (wet grinding)
MDG	Metal for diamants pins wheel
MDB	Metal for CBN pins wheel

# Grinding wheels

## 1A1R

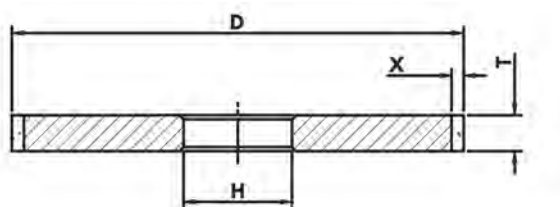

Item No	D	X	H	T	Grift	Concentration	Bond
<b>Ø 75</b>							
1A1R-3524	75	6	10H6	0.8	D126	C100	RLG
1A1R-3522	75	6	10H6	0.8	D126	C100	PSG2
1A1R-3523	75	6	20H6	0.8	D126	C100	RLG
1A1R-934	75	6	20H6	0.8	D126	C100	PSG2
1A1R-892	75	6	20H6	0.8	B151	C100	PSG
<b>Ø 100</b>							
1A1R-912	100	6	20H6	0.9	D126	C100	PSG
1A1R-939	100	6	20H6	0.9	B151	C100	PSG
<b>Ø 125</b>							
1A1R-935	125	6	20H6	1	D126	C100	PSG
1A1R-940	125	6	20H6	1	B151	C100	PSG
<b>Ø 150</b>							
1A1R-848	150	6	30H6	1	D126	C100	PSG
1A1R-895	150	6	20H6	1	D126	C100	PSG
1A1R-919	150	6	22H6	1	D126	C100	PSG
1A1R-941	150	6	20H6	1	B151	C100	PSG
<b>Ø 175</b>							
1A1R-897	175	6	20H6	1.2	D126	C100	PSG
1A1R-942	175	6	20H6	1.2	B151	C100	PSG
1A1R-849	175	6	30H6	1.2	D126	C100	PSG
1A1R-943	175	6	30H6	1.2	B151	C100	PSG
<b>Ø 200</b>							
1A1R-936	200	6	20H6	1.3	D126	C100	PSG
1A1R-944	200	6	20H6	1.3	B151	C100	PSG
<b>Ø 250</b>							
1A1R-3528	250	6	32H6	1.3	D126	C100	PSG
1A1R-3529	250	6	32H6	1.3	B151	C100	PSG
1A1R-3530	250	6	32H6	1.3	D126	C100	PSG
1A1R-3531	250	6	32H6	1.3	B151	C100	PSG

# Grinding wheels

1A8

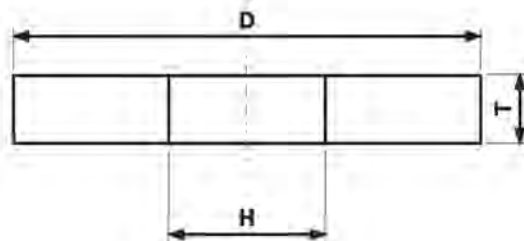

Item No	D	H	T	Grift	Concentration	Bond
<b>Ø 12</b>						
1A8-2142	12	4	1.1±0.01	D25	C100	PSQN
1A8-2143	12	4	1.1±0.01	D40	C100	PSQN
1A8-2144	12	4	1.1±0.01	D76	C100	PSE
1A8-2145	12	4	1+0.3	D15	C100	PSQN
1A8-2146	12	4	1+0.3	D25	C100	PSQN
1A8-2147	12	4	1+0.3	D76	C100	PSE
1A8-2148	12	4	2+0.2	D15	C100	PSQN
1A8-2149	12	4	2+0.2	D25	C100	PSQN
1A8-2150	12	4	2+0.2	D76	C100	PSE
<b>Ø 14</b>						
1A8-2151	14	4	1+0.3	D15	C100	PSQN
1A8-2152	14	4	1+0.3	D25	C100	PSQN
1A8-2153	14	4	1+0.33	D76	C100	PSE
1A8-2154	14	4	2+0.2	D15	C100	PSQN
1A8-2155	14	4	2+0.2	D25	C100	PSQN
1A8-2156	14	4	2+0.2	D76	C100	PSE
<b>Ø 16</b>						
1A8-2157	16	4	1.1±0.01	D25	C100	PSQN
1A8-2158	16	4	1.1±0.01	D40	C100	PSQN
1A8-2159	16	4	1.1±0.01	D54	C100	PSE
1A8-2160	16	4	1.1±0.01	D76	C100	PSE
1A8-2161	16	4	1+0.3	D15	C100	PSQN
1A8-2162	16	4	1+0.3	D25	C100	PSQN
1A8-2163	16	4	1+0.3	D76	C100	PSE
1A8-2164	16	4	2±0.01	D25	C100	PSQN
1A8-2165	16	4	2±0.01	D40	C100	PSQN
1A8-2166	16	4	2±0.01	D76	C100	PSE
1A8-2167	16	4	2±0.2	D15	C100	PSQN
1A8-2168	16	4	2±0.2	D25	C100	PSQN
1A8-2169	16	4	2±0.2	D76	C100	PSE
<b>Ø 20</b>						
1A8-2170	20	4	1.1±0.01	D25	C100	PSQN
1A8-2171	20	4	1.1±0.01	D40	C100	PSQN
1A8-2172	20	4	1.1±0.01	D76	C100	PSE
1A8-2173	20	4	1+0.3	D15	C100	PSQN
1A8-2174	20	4	1+0.3	D25	C100	PSQN
1A8-2175	20	4	1+0.3	D76	C100	PSE
1A8-2176	20	4	2±0.01	D25	C100	PSQN
1A8-2177	20	4	2±0.01	D40	C100	PSQN
1A8-2178	20	4	2±0.01	D76	C100	PSE
1A8-2179	20	4	2+0.2	D15	C100	PSQN
1A8-2180	20	4	2+0.2	D25	C100	PSQN

# Grinding wheels

1A8

continuation ...

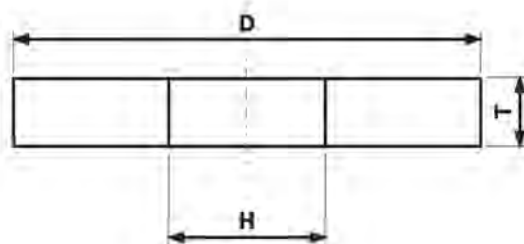

Item No	D	H	T	Grift	Concentration	Bond
<b>Ø 20</b>						
1A8-2181	20	4	2+0.2	D76	C100	PSE
1A8-3200	20	10H6	5	D15	C100	PSQ
1A8-3201	20	10H6	5	D30	C100	PSQ
1A8-3202	20	10H6	5	D76	C100	PSE
1A8-3203	20	10H6	5	D126	C100	PSE
<b>Ø 25</b>						
1A8-3204	25	10H6	5	D15	C100	PSQ
1A8-3205	25	10H6	5	D30	C100	PSQ
1A8-3206	25	10H6	5	D76	C100	PSE
1A8-3207	25	10H6	5	D126	C100	PSE
<b>Ø 27</b>						
1A8-3315	27	10	1±0.3	D15	C100	PSQN
1A8-3316	27	10	1±0.3	D76	C100	PSE
1A8-3317	27	10	2+0.2	D15	C100	PSQN
1A8-3318	27	10	2+0.2	D76	C100	PSE
<b>Ø 32</b>						
1A8-2182	32	10	1.1+/-0.01	D25	C100	PSQN
1A8-2183	32	10	1.1+/-0.01	D40	C100	PSQN
1A8-2184	32	10	1.1+/-0.01	D76	C100	PSE
1A8-2185	32	10	1+0.3	D15	C100	PSQN
1A8-2186	32	10	1+0.3	D25	C100	PSQN
1A8-2187	32	10	1+0.3	D76	C100	PSE
1A8-2188	32	10	2+/-0.01	D25	C100	PSQN
1A8-2189	32	10	2+/-0.01	D40	C100	PSQN
1A8-2190	32	10	2+/-0.01	D76	C100	PSE
1A8-2191	32	10	2+0.2	D15	C100	PSQN
1A8-2192	32	10	2+0.2	D25	C100	PSQN
1A8-2193	32	10	2+0.2	D76	C100	PSE
1A8-2194	32	10	3+/-0.01	D15	C100	PSQN
1A8-2195	32	10	3+/-0.01	D25	C100	PSQN
1A8-2196	32	10	3+/-0.01	D40	C100	PSQN
1A8-2197	32	10	3+/-0.01	D76	C100	PSE
<b>Ø 40</b>						
1A8-2198	40	10	1+0.3	D15	C100	PSQN
1A8-2199	40	10	1+0.3	D25	C100	PSQN
1A8-2200	40	10	1+0.3	D76	C100	PSE
1A8-2201	40	10	2+0.2	D15	C100	PSQN
1A8-2202	40	10	2+0.2	D25	C100	PSQN
1A8-2203	40	10	2+0.2	D76	C100	PSE
1A8-3355	40	6	0.4	D107	C100	GGG
1A8-3356	40	6	0.5	D107	C100	GGG
1A8-3357	40	6	0.6	D107	C100	GGG
1A8-3358	40	6	0.7	D107	C100	GGG
1A8-3359	40	6	0.8	D107	C100	GGG
1A8-3360	40	6	0.9	D107	C100	GGG
1A8-3361	40	6	1.0	D107	C100	GGG

# Grinding wheels

1A8

continuation ...

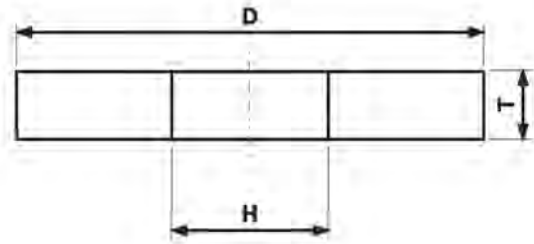

Item No	D	H	T	Grif	Concentration	Bond
<b>Ø 40</b>						
1A8-3362	40	6	1.2	D107	C100	GG5

# Grinding wheels

1A1

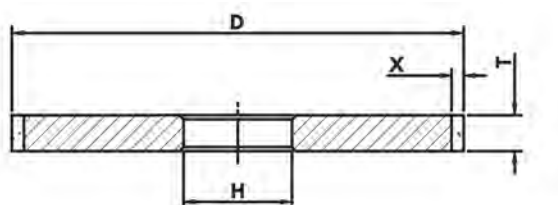

Item No	D	X	H	T	Grift	Concentration	Bond
<b>Ø 30</b>							
1A1-3400	30	3	10H6	5	D15	C100	PSQ
1A1-3401	30	3	10H6	5	D30	C100	PSQ
1A1-3402	30	3	10H6	5	D76	C100	PSE
1A1-3403	30	3	10H6	5	D126	C100	PSE
<b>Ø 40</b>							
1A1-3404	40	3	10H6	5	D15	C100	PSQ
1A1-3405	40	3	10H6	5	D30	C100	PSQ
1A1-3406	40	3	10H6	5	D76	C100	PSE
1A1-3407	40	3	10H6	5	D126	C100	PSE
<b>Ø 50</b>							
1A1-3408	50	3	10H6	5	D15	C100	PSQ
1A1-3409	50	3	10H6	5	D30	C100	PSQ
1A1-3410	50	3	10H6	5	D76	C100	PSE
1A1-3411	50	3	10H6	5	D126	C100	PSE
<b>Ø 60</b>							
1A1-3412	60	3	10H6	5	D15	C100	P'SQ
1A1-3413	60	3	10H6	5	D30	C100	PSQ
1A1-3414	60	3	10H6	5	D76	C100	PSE
1A1-3415	60	3	10H6	5	D126	C100	PSE
<b>Ø 75</b>							
1A1-3416	75	3	10H6	5	D15	C100	PSQ
1A1-3417	75	3	10H6	5	D30	C100	PSQ
1A1-3418	75	3	10H6	5	D76	C100	PSE
1A1-3419	75	3	10H6	5	D126	C100	PSE
1A1-3501	75	5	20H6	5	D64	C100	F11
1A1-3507	75	5	20H6	5	D54	C100	F1
1A1-1016-D75	75	3	20H6	6	D20	C100	PSE
1A1-1015-D75	75	3	20H6	6	D76	C100	GGE
1A1-1034	75	3	20H6	6	D126	C100	GGE
1A1-3506	75	5	20H6	6	D76	C100	F11
1A1-2139-D100	75	5	20H6	6	D30	C75	GGs
1A1-1040	75	4	20H6	8	D20	C75	PSQ
1A1-2138-D75	75	5	20H6	10	D76	C100	GGs
1A1-3502	75	5	20H6	10	D54	C100	F1
<b>Ø 80</b>							
1A1-2141	80	8	20H6	12	D76	C100	GGs
<b>Ø 100</b>							
1A1-3420	100	3	20H6	5	D30	C100	PSQ
1A1-3421	100	3	20H6	5	D76	C100	PSE
1A1-3422	100	3	20H6	5	D126	C100	PSE
1A1-3718	100	3	20H6	6	D20	C100	PSE
1A1-3717	100	3	20H6	6	D76	C100	PSE
1A1-1017	100	3	20H6	6	D126	C100	PSE
1A1-3503	100	3	20H6	6	D54	C100	F1

# Grinding wheels

1A1

continuation ...

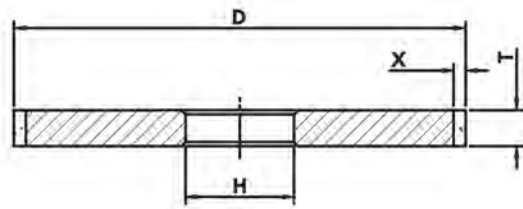

Item No	D	X	H	T	Grift	Concentration	Bond
<b>Ø 100</b>							
1A1-2139	100	5	20H6	8	D30	C75	GG5
1A1-2140	100	5	20H6	8	D20	C100	JMK3
1A1-2138-100	100	5	20H	10	D30	C100	JMK3
1A1-3504	100	10	20H	10	D54	C100	F1

# Grinding wheels

14A1

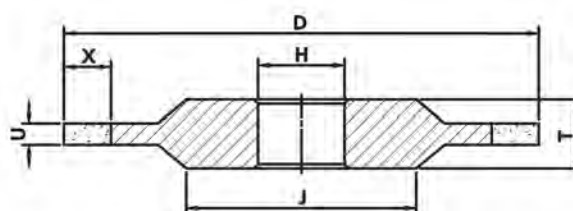
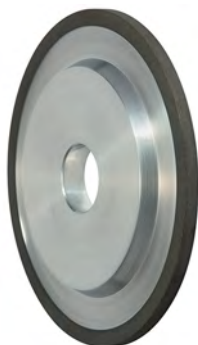

Item No	D	U	X	H	T	Grift	Concentration	Bond
<b>Ø 75</b>								
14A1-2099	75	2	3	20H6	6-8	D7	C100	PSQ
14A-2100	75	3	4	20H6	6-8	D10	C100	PSQ
14A1-2101	75	3	4	20H6	6-8	D15	C100	PSQ
14A1-2102	75	3	4	20H6	6-8	D20	C100	PSQ
14A1-2103	75	3	4	20H6	6-8	D30	C100	GGs
14A1-2131	75	5	5	20H6	6-8	D46	C75	GGs
14A1-2104	75	6	6	20H6	6-8	D20	C100	PSQ
14A1-2105	75	6	6	20H6	6-8	D30	C100	GGs
14A1-2106	75	6	6	20H6	6-8	D46	C100	GGs
14A1-2107	75	6	6	20H6	6-8	D54	C100	GGs
14A1-2108	75	6	6	20H6	6-8	D64	C100	GGs
14A1-2109	75	6	6	20H6	6-8	D76	C100	GGs
14A1-2110	75	6	6	20H6	6-8	D91	C100	GGs
14A1-2111	75	8	6	20H6	8-10	D64	C100	GGs
14A1-2112	75	8	6	20H6	8-10	D91	C100	GGs
<b>Ø 100</b>								
14A1-2087	100	3	4	20H6	6-8	D20	C100	PSQ
14A1-2088	100	3	4	20H6	6-8	D30	C100	GGs
14A1-2093	100	6	6	20H6	8-10	D20	C100	PSQ
14A1-2094	100	6	6	20H6	8-10	D30	C100	GGs
14A1-2095	100	6	6	20H6	8-10	D46	C100	GGs
14A1-2096	100	8	6	20H6	8-10	D64	C100	GGs
14A1-2097	100	8	6	20H6	8-10	D76	C100	GGs
14A1-2098	100	8	6	20H6	8-10	D91	C100	GGs
14A1-2084	100	10	6	20H6	10	D64	C100	GGs
14A1-2085	100	10	6	20H6	10	D76	C100	GGs
14A1-2086	100	10	6	20H6	10	D91	C100	GGs

# Grinding wheels

3A1

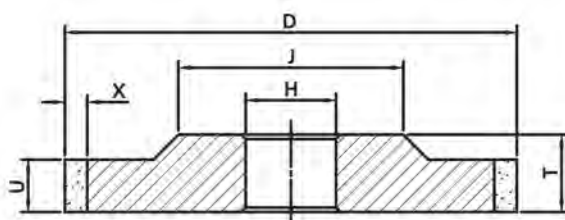
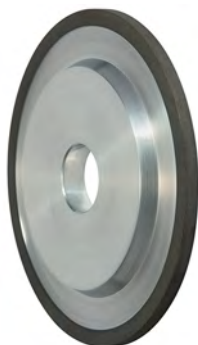

Item No	D	U	X	H	T	Grift	Concentration	Bond
<b>Ø 75</b>								
3A1-2214	75	1.5	5	20H6	6-8	D126	C100	GGSP
3A1-2215	75	1.5	5	20H6	6-8	D20B	C100	GGSP
3A1-2216	75	1	5	20H6	6-8	D126	C100	GGSP
3A1-2217	75	1	5	20H6	6-8	D20B	C100	GGSP
3A1-2218	75	2.5	5	20H6	6-8	D20B	C100	PSQ
3A1-2219	75	2.5	5	20H6	6-8	D126	C100	GGSP
3A1-2220	75	2	5	20H6	6-8	D126	C100	GGSP
3A1-2221	75	2	5	20H6	6-8	D20B	C100	PSQ
3A1-2222	75	3	5	20H6	6-8	D126	C100	GGSP
3A1-2223	75	3	5	20H6	6-8	D20B	C100	PSQ
3A1-2224	75	5	5	20H6	6-8	D30	C125	GGX
<b>Ø 80</b>								
3A1-2225	80	6	8	20H6	6-8	D76	C100	GGs
<b>Ø 100</b>								
3A1-2212	100	1	5	20H6	6-8	D126	C100	GGSP
3A1-2213	100	1	5	20H6	6-8	D20	C100	JMK3
<b>Ø 75</b>								
3A1-3515	75	1.5	5	20H6	6-8	D126	C100	PSQ
3A1-3516	75	1.5	5	20H6	6-8	D20B	C100	PSQ
3A1-3617	75	1	5	20H6	6-8	D126	C100	PSQ
3A1-3518	75	1	5	20H6	6-8	D20B	C100	PSQ
3A1-3519	75	2.5	5	20H6	6-8	D20B	C100	PSQ
3A1-3520	75	2.5	5	20H6	6-8	D126	C100	PSQ
3A1-3521	75	2	5	20H6	6-8	D126	C100	PSQ
3A1-3522	75	2	5	20H6	6-8	D20B	C100	PSQ
3A1-3523	75	3	5	20H6	6-8	D126	C100	PSQ
3A1-3524	75	3	5	20H6	6-8	D20B	C100	PSQ
3A1-3525	75	5	5	20H6	6-8	D30	C100	PSQ
<b>Ø 80</b>								
3A1-2526	80	6	8	20H5	6-8	D76	C100	PSQ
<b>Ø 100</b>								
3A1-3527	100	1	5	20H6	6-8	D126	C100	PSQ
3A1-3528	100	1	5	20H6	6-8	D20	C100	PSQ

# Grinding wheels

3F1

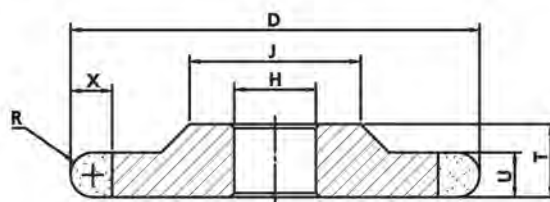
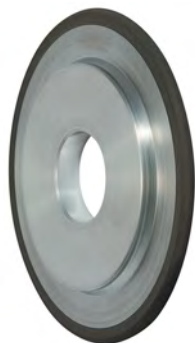

Item No	D	U	X	H	T	Grift	Concentration	Bond
<b>Ø 75</b>								
3F1-2226	75	1.5	5	20h6	6-8	D126	C100	GGSP
3F1-2227	75	1	5	20H6	6-8	D126	C100	GGSP
3F1-2230	75	2	5	20H6	6-8	D126	C100	GGSP
3F1-2231	75	2	5	20H6	6-8	D20B	C100	PSQ
3F1-2228	75	2.5	5	20H6	6-8	D126	C100	GGSP
3F1-2229	75	2.5	5	20H6	6-8	D20B	C100	PSQ
3F1-2233	75	3	5	20H6	6-8	D126	C100	GGSP
3F1-2234	75	3	5	20H6	6-8	D20B	C100	GGSP
3F1-2235	75	3	5	20H6	6-8	D20B	C100	PSQ
3F1-3529	75	1.5	5	20H6	6-8	D126	C100	PSE
3F1-3530	75	1	5	20H6	6-8	D20B	C100	PSE
3F1-3531	75	2	5	20H6	6-8	D126	C100	PSE
3F1-3532	75	2	5	20H6	6-8	D20B	C100	PSE
3F1-3533	75	2.5	5	20H6	6-8	D20B	C100	PSE
3F1-3534	75	2.5	5	20H6	6-8	D126	C100	PSE
3F1-3535	75	3	5	20H6	6-8	D126	C100	PSE
3F1-3536	75	3	5	20H6	6-8	D20B	C100	PSE
3F1-3537	75	3	5	20H6	6-8	D126	C100	PSE

# Grinding wheels

1V1

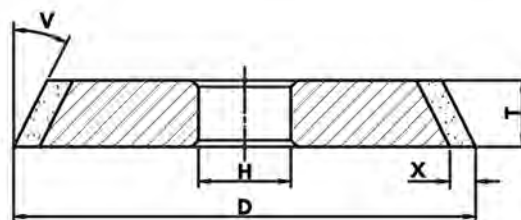

Item No	D	V°	U	X	H	T	Grift	Concentration	Bond
<b>Ø 75</b>									
1V1-2207	75	20	5	5	20H6	6	D15	C100	JMK3
1V1-2208	75	20	6	5	20H6	6	D30	C75	GGs
1V1-2209	75	20	6	5	20H6	6	D76	C75	GGs
1V1-2206	75	20	10	5	20H6	10	D46	C100	GGs
1V1-2210	75	45	6	5	20H6	6	D30	C75	GGs
<b>Ø 100</b>									
1V1-2204	100	15	6	6	25H6	6	D46	C125	GGV
1V1-2205	100	15	6	6	35H6		D46	C125	GGV
<b>Ø 125</b>									
1V1-2211	125	45	12	6	20H6	12	D126	C100	GGs

# Grinding wheels

3V1

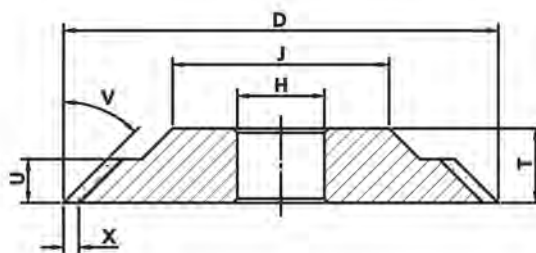
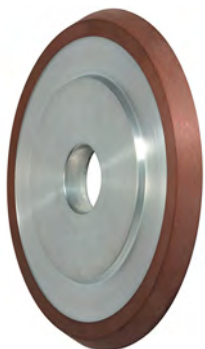

Item No	D	V°	U	X	H	T	Grift	Concentration	Bond
<b>Ø 50</b>									
3V1-2248	50	20	6	5	20H6	6-8	D46	C100	GGSP
3V1-2249	50	20	6	5	20H6	6-8	D30-K	C100	GGSP
<b>Ø 75</b>									
3V1-2236	75	10	5	5	20H6	6-8	D46	C100	GGSP
3V1-3459	75	20	3	6	20H6	6-8	D30	C100	F11
3V1-3460	75	45	4	6	20H6	6-8	D30	C100	F11
3V1-3461	75	20	5	5	20H6	6-8	D30	C100	F11
3V1-3462	75	20	5	5	20H6	6-8	D46	C100	F11
3V1-3463	75	20	5	5	20H6	6-8	D64	C100	F11
3V1-3464	75	20	5	5	20H6	6-8	D91	C100	F11
3V1-3465	75	45	5	6	20H6	6-8	D64	C100	F11
<b>Ø 100</b>									
3V1-3466	100	20	3	6	20H6	6-8	D30	C100	F11
3V1-3467	100	45	4	6	20H6	6-8	D30	C100	F11
3V1-3468	100	20	5	6	20H6	6-8	D30	C100	F11
3V1-3469	100	20	5	6	20H6	6-8	D46	C100	F11
3V1-3470	100	20	5	6	20H6	6-8	D64	C100	F11
3V1-3471	100	20	5	6	20H6	6-8	D91	C100	F11
3V1-2237	100	15	2	6	35H6	6-8	D20	C125	GGV
3V1-2238	100	15	3	6	25H6	6-8	D20	C125	GGV
3V1-2239	100	15	3	6	25H6	6-8	D25	C125	GGV
3V1-2240	100	15	3	6	25H6	6-8	D30	C125	GGV
3V1-2241	100	15	4	6	25H6	6-8	D35	C125	GGV
3V1-2242	100	15	4	6	35H6	6-8	D30	C125	GGV
<b>Ø 125</b>									
3V1-3472	125	20	3	6	20H6	6-8	D30	C100	F11
3V1-3473	125	45	5	6	20H6	6-8	D30	C100	F11
3V1-3474	125	20	5	6	20H6	6-8	D30	C100	F11
3V1-3475	125	20	5	6	20H6	6-8	D46	C100	F11
3V1-3476	125	20	5	6	20H6	6-8	D64	C100	F11
3V1-3477	125	20	5	6	20H6	6-8	D91	C100	F11
3V1-3478	125	20	8	8	20H6	8-10	D54	C100	F1
3V1-3479	125	20	10	10	20H6	10-12	D54	C100	F1
<b>Ø 150</b>									
3V1-2243	150	15	3	6	50H6	8-10	D20	C125	GGV
3V1-2244	150	15	3	6	50H6	8-10	D35	C125	GGV
3V1-2245	150	15	4	6	50H6	8-10	D35	C125	GGV
3V1-2246	150	15	6	6	50H6	8-10	D35	C125	GGV
3V1-2247	150	15	6	6	50H6	8-10	D46	C100	GGSP

# Grinding wheels

14V1

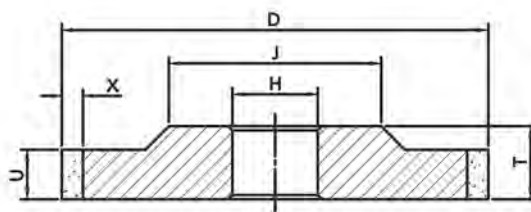

Item No	D	V°	U	X	H	T	Grift	Concentration	Bond
<b>Ø 75</b>									
14V1-2115	75	20	3	6	20H6	6-8	D10	C100	PSQ
14V1-2116	75	20	3	6	20H6	6-8	D20	C100	PSQ
14V1-2117	75	20	3	6	20H6	6-8	D30	C100	GGs
14V1-2122	75	45	4	6	20H6	6-8	D30	C100	GGs
14V1-2118	75	20	5	5	20H6	6-8	D30	C100	JMK3
14V1-2119	75	20	5	5	20H6	6-8	D46	C100	GGs
14V1-2120	75	20	5	5	20H6	6-8	D64	C100	GGs
14V1-2121	75	20	5	5	20H6	6-8	D91	C100	GGs
14V1-3440	75	20	3	6	20h6	6-8	D30	C100	F11
14V1-3441	75	45	4	6	20H6	6-8	D30	C100	F11
14V1-3442	75	20	5	5	20H6	6-8	D30	C100	F11
14V1-3443	75	20	5	5	20H6	6-8	D46	C100	F11
14V1-3444	75	20	5	5	20H6	6-8	D64	C100	F11
14V1-3445	75	20	5	5	20H6	6-8	D91	C100	F11
14V1-2123	75	45	5	6	20H6	6-8	D10	C100	PSQ
14V1-2124	75	45	5	6	20H6	6-8	D15	C100	JMK3
14V1-2125	75	45	5	6	20H6	6-8	D20	C100	JMK3
14V1-2126	75	45	5	6	20H6	6-8	D46	C100	GGs
14V1-2127	75	45	5	6	20H6	6-8	D64	C100	GGs
14V1-2128	75	45	5	6	20H6	6-8	D76	C100	GGs
14V1-2129	75	45	5	6	20H6	6-8	D91	C100	GGs
14V1-3446	75	45	5	6	20H6	6-8	D64	C100	F11
<b>Ø 80</b>									
14V1-2130	80	45/3	5	5	20H6	6-8	D64	C100	GGs
<b>Ø 100</b>									
14V1-3447	100	20	3	6	20H6	6-8	D54	C100	F11
14V1-3448	100	20	4	6	20H6	6-8	D54	C100	F11
14V1-3449	100	20	5	6	20H6	6-8	D54	C100	F11
14V1-3450	100	20	6	6	20H6	6-8	D54	C100	F11
14V1-3451	100	20	8	6	20H6	6-8	D54	C100	F1
14V1-3452	100	20	10	6	20H6	10	D54	C100	F1
14V1-3453	100	45	3	6	20H6	6-8	D54	C100	F11
14V1-3454	100	45	4	6	20H6	6-8	D54	C100	F11
14V1-3455	100	45	5	6	20H6	6-8	D54	C100	F11
14V1-3456	100	45	6	6	20H6	6-8	D54	C100	F11
14V1-3457	100	45	8	6	20H6	6-8	D54	C100	F1
14V1-3458	100	45	10	6	20H6	10	D54	C100	F1

# Grinding wheels

12A2 45°

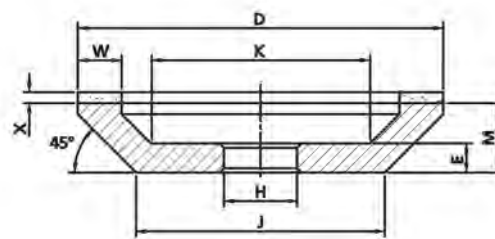

$$M + X = 25$$



Item No	D	W	X	H	Grift	Concentration	Bond
<b>Ø 75</b>							
12A2-ATV1	75	3	4	20	D5	C30	PSE/3KS
12A2-ATV2	75	3	4	20	D7	C50	PSE/3KS
12A2-ATV3	75	3	4	20	D10	C50	PSE/3KS
12A2-ATV4	75	3	4	20	D15A	C75	PSC
12A2-ATV5	75	3	4	20	D15	C75	PSC
12A2-ATV6	75	3	4	20	D15B	C75	PSC
12A2-ATV7	75	3	4	20	D15C	C75	PSC
12A2-922	75	3	4	20H6	D10	C75	PSE
12A2-537	75	3	4	20H6	D15A	C75	PSE2
12A2-2349	75	3	4	20H6	D15	C75	PSE/2KS
12A2-466	75	3	4	20H6	D15	C75	PSE2
12A2-34	75	3	4	20H6	D20	C100	PSE
12A2-2038	75	3	4	20H6	D25	C50	PSE
12A2-36	75	3	4	20H6	D30	C100	PSE
12A2-38	75	3	4	20H6	D46	C100	PSE
12A2-41	75	3	4	20H6	D54	C100	PSE
12A2-44	75	3	4	20H6	D64	C100	PSE
12A2-45	75	3	4	20H6	D76	C100	PSE
12A2-47	75	3	4	20H6	D91	C100	PSE
12A2-25	75	3	4	20H6	D126	C100	GGs
12A2-26	75	3	4	20H6	D126	C100	PSE
12A2-33	75	3	4	20H6	D151	C100	PSE
12A2-1052	75	3	4	20H6	D181	C100	PSE
12A2-858	75	3	4	20H6	B15	C100	PSE
12A2-1065	75	3	4	20H6	B30	C75	PSE
12A2-513	75	3	4	20H6	B54	C75	PSE
12A2-24	75	3	4	20H6	B76	C75	PSE
12A2-21	75	3	4	20H6	B151	C75	PSE
12A2-931	75	3	4	20H6	B126	C75	PSE
12A2-3566	75	5	5	20H6	D46	C100	F11
12A2-3567	75	5	5	20H6	D91	C100	F11
12A2-2050	75	6	4	20H6	D7	C100	PSQ
12A2-2051	75	6	4	20H6	D10	C100	PSQ
12A2-2052	75	6	4	20H6	D15	C100	PSQ
12A2-2053	75	6	4	20H6	D20	C100	PSQ
12A2-2054	75	6	4	20H6	D30	C100	GGs
12A2-2055	75	6	4	20H6	D46	C100	GGs
12A2-2056	75	6	4	20H6	D64	C100	GGs
12A2-2057	75	6	4	20H6	D76	C100	GGs
12A2-2058	75	6	4	20H6	D91	C100	GGs
12A2-3568	75	10	5	20H6	D46	C100	F11

# Grinding wheels

12A2 45°

continuation ...

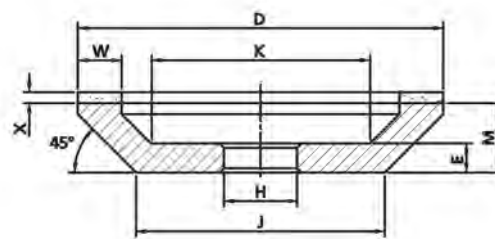

$$M + X = 25$$

Item No	D	W	X	H	Grift	Concentration	Bond
<b>Ø 75</b>							
12A2-3569	75	10	5	20H6	D91	C100	F11
<b>Ø 100</b>							
12A2-2028	100	6	4	20H6	D3	C50	PSQ
12A2-2031	100	6	4	20H6	D6	C50	PSQ
12A2-2024	100	6	4	20H6	D10	C100	PSQ
12A2-2026	100	6	4	20H6	D15	C100	PSQ
12A2-2027	100	6	4	20H6	D20	C100	PSQ
12A2-2029	100	6	4	20H6	D30	C100	GGs
12A2-2030	100	6	4	20H6	D46	C100	GGs
12A2-2032	100	6	4	20H6	D76	C100	GGs
12A2-2033	100	6	4	20H6	D91	C100	GGs
12A2-2035	100	6	4	20H6	D126	C100	GGs
12A2-3570	100	6	4	20H6	D30	C100	F11
12A2-3571	100	6	4	20H6	D46	C100	F11
12A2-3572	100	6	4	20H6	D76	C100	F11
12A2-3573	100	6	4	20H6	D91	C100	F11
12A2-3574	100	6	4	20H6	D126	C100	F11
12A2-2022	100	10	4	20H6	D6	C50	PSQ
12A2-2019	100	10	4	20H6	D10	C100	PSQ
12A2-2021	100	10	4	20H6	D20	C100	PSQ
12A2-3575	100	10	4	20H6	D30	C100	F11
12A2-3576	100	10	4	20H6	D46	C100	F11
12A2-3577	100	10	4	20H6	D76	C100	F11
12A2-3578	100	10	4	20H6	D91	C100	F11
12A2-2023	100	10	4	20H6	D91	C100	GGs
12A2-2020	100	10	4	20H6	D126	C100	GGs
12A2-3579	100	10	4	20H6	D126	C100	F11

# Grinding wheels

## 12A2 45° EW

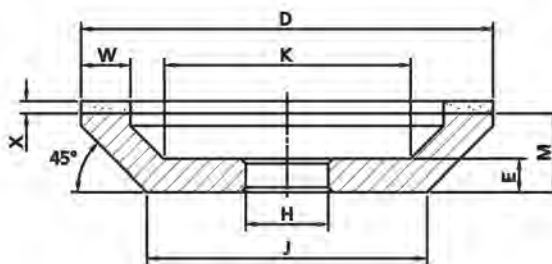

$$M + X = 25$$

For Ewag machine WS11 (developpement :  
Unirock SA, 1998)  
Single piece wheel of hub



Item No	D	W	X	Grift	Concentration	Bond
<b>Ø 75</b>						
12A2-EW-898	75	3	4	D10	C50	PSE2
12A2-EW-553	75	3	4	D15	C75	PSE2
12A2-EW-568	75	3	4	D20	C100	PSE
12A2-EW-577	75	3	4	D30	C100	PSE
12A2-EW-645	75	3	4	D46	C100	PSE
12A2-EW-554	75	3	4	D54	C100	PSE
12A2-EW-555	75	3	4	D64	C100	PSE
12A2-EW-673	75	3	4	D76	C100	PSE
12A2-EW-571	75	3	4	D91	C100	PSE
12A2-EW-556	75	3	4	D126	C100	GGs
12A2-EW-565	75	3	4	D126	C100	PSE
12A2-EW-872	75	3	4	D151	C100	PSE
12A2-EW-884	75	3	4	B15	C50	PSE
12A2-EW-790	75	3	4	B15	C75	PSE
12A2-EW-806	75	3	4	B20	C75	PSE2
12A2-EW-885	75	3	4	B30	C75	PSE
12A2-EW-803	75	3	4	B54	C75	PSE
12A2-EW-871	75	3	4	B46	C75	PSE
12A2-EW-926	75	3	4	B76	C75	PSE
12A2-EW-930	75	3	4	B91	C75	PSE
12A2-EW-780	75	3	4	B126	C75	PSE
12A2-EW-928	75	3	4	B151	C75	PSE

# Grinding wheels

6A2

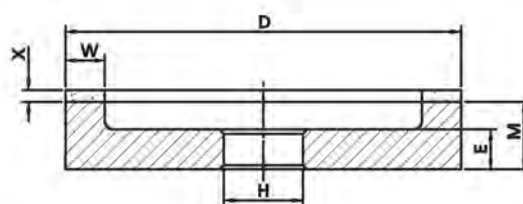
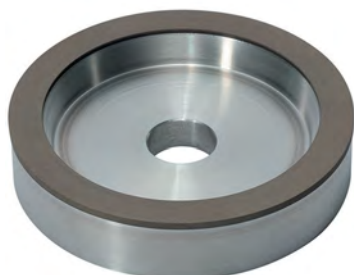

$$T = M + X \quad E = 25$$



Item No	D	W	X	H	T	Grift	Concentration	Bond
<b>Ø 100</b>								
6A2-2261	100	5	4	20H6	25	D20	C75	PSQ
6A2-2262	100	5	4	20H6	25	D46	C75	GGG
6A2-2264	100	5	4	20H6	25	D64	C75	GGG
6A2-2027	100	6	4	20H6	25	D20	C100	PSQ
6A2-2265	100	8	3	25H6	13	D10	C100	PSQ
6A2-2266	100	8	3	25H6	13	D15	C100	GGG
6A2-2267	100	8	3	25H6	13	D20	C100	GGG
6A2-2259	100	12	5	20H6	25	D54	C100	GGG
6A2-3557	100	15	5	20H6	25	D64	C100	F11
6A2-3558	100	20	5	20H6	25	D64	C100	F11
<b>Ø 125</b>								
6A2-3559	125	10	4	20H6	25	D76	C100	F11
6A2-3560	125	12	4	20H6	25	D76	C100	F11
6A2-3561	125	15	4	20H6	25	D91	C100	F11
6A2-3562	125	20	4	20H6	25	D91	C100	F11
<b>Ø 140</b>								
6A2-2271	140	6	4	40H6	40	D30	C100	GGG
6A2-2272	140	6	4	40H6	40	D46	C100	GGG
6A2-2273	140	6	4	40H6	40	D54	C100	GGG
6A2-2268	140	10	4	40H6	40	D30	C100	GGG
6A2-2269	140	10	4	40H6	40	D46	C100	GGG
6A2-2270	140	10	4	40H6	40	D54	C100	GGG
<b>Ø 150</b>								
6A2-3563	150	10	4	20H6	25	D76	C100	F11
6A2-3564	150	15	4	20H6	25	D91	C100	F11
6A2-3565	150	20	4	20H6	25	D91	C100	F11

# Grinding wheels

11V9

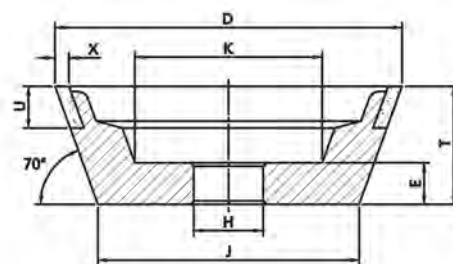

D = 75 E = 10 T = 25  
D = 100 E = 10 T = 35



Item No	D	U	X	H	Grift	Concentration	Bond
<b>Ø 75</b>							
11V9-1012	75	2	10	20H6	D15	C75	PSE
11V9-719	75	2	10	20H6	D25	C75	PSE
11V9-720	75	2	10	20H6	D20	C75	PSE
11V9-920	75	2	10	20H6	D46	C100	GGs
11V9-485	75	2	10	20H6	D126	C75	PSE
11V9-3580	75	2	10	20H6	D54	C100	F11
11V9-3581	75	2	10	20H6	D91	C100	F11
11V9-2016	75	3	10	20H6	D7	C100	PSQ
11V9-2010	75	3	10	20H6	D10	C100	PSQ
11V9-2011	75	3	10	20H6	D15	C100	PSQ
11V9-2012	75	3	10	20H6	D20	C100	PSQ
11V9-2013	75	3	10	20H6	D30	C100	GGs
11V9-2014	75	3	10	20H6	D30	C100	PSQ
11V9-2015	75	3	10	20H6	D46	C100	GGs
11V9-2017	75	3	10	20H6	D76	C100	GGs
11V9-3582	75	3	10	20H6	D54	C100	F11
11V9-3583	75	3	10	20H6	D91	C100	F11
<b>Ø 100</b>							
11V9-6	100	2	10	20H6	D30	C75	PSE
11V9-7	100	2	10	20H6	D91	C75	GGE
11V9-2000	100	2	10	20H6	D126	C75	GGE
11V9-658	100	3	10	20H6	D15	C100	PSE
11V9-659	100	3	10	20H6	D64	C75	PSE
11V9-660	100	3	10	20H6	D64	C100	GGs
11V9-667	100	3	10	20H6	D126	C100	GGs
11V9-842	100	3	10	20H6	D126	C100	PSE
11V9-2001	100	3	10	20H6	D10	C100	PSQ
11V9-2002	100	3	10	20H6	D15	C100	PSQ
11V9-2003	100	3	10	20H6	D20	C100	PSQ
11V9-2004	100	3	10	20H6	D30	C100	GGs
11V9-2005	100	3	10	20H6	D46	C100	GGs
11V9-2006	100	3	10	20H6	D46	C100	GGs
11V9-2007	100	3	10	20H6	D64	C100	GGs
11V9-2008	100	3	10	20H6	D76	C100	GGs
11V9-2009	100	3	10	20H6	D91	C100	GGs
11V9-3584	100	3	10	20H6	D54	C100	F11
11V9-3585	100	3	10	20H6	D91	C100	F11

# Grinding wheels

12V9

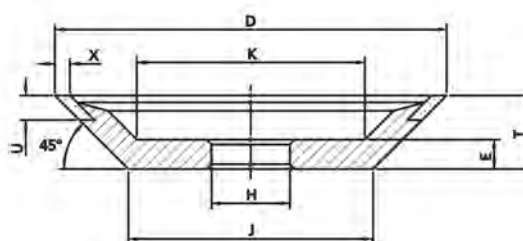

Item No	D	W	X	H	T	Grift	Concentration	Bond
<b>Ø 35</b>								
12V9-3600	35	3	3	10H6	15	D7	C100	PSQ
12V9-3601	35	3	3	10H6	15	D15	C100	PSQ
12V9-3602	35	3	3	10H6	15	D25	C100	PSQ
12V9-3603	35	3	3	10H6	15	D54	C100	PSE
12V9-3604	35	3	3	10H6	15	D126	C100	PSE
<b>Ø 50</b>								
12V9-3605	50	3	6	10H6	15	D7	C100	PSQ
12V9-3606	50	3	6	10H6	15	D15	C100	PSQ
12V9-3607	50	3	6	10H6	15	D25	C100	PSQ
12V9-3608	50	3	6	10H6	15	D54	C100	PSE
12V9-3609	50	3	6	10H6	15	D126	C100	PSE
<b>Ø 75</b>								
12V9-2075	75	2	6	20H6	20	D10	C100	PSQ
12V9-2076	75	2	6	20H6	20	D15	C100	JMK3
12V9-2077	75	2	6	20H6	20	D20	C100	JMK3
12V9-2078	75	2	6	20H6	20	D20	C100	PSQ
12V9-2079	75	2	6	20H6	20	D30	C100	JMK3
12V9-3551	75	2	6	20H6	20	D46	C100	F11
12V9-2080	75	2	6	20H6	20	D46	C100	JMK3
12V9-2081	75	2	6	20H6	20	D64	C100	JMK3
12V9-2082	75	2	6	20H6	20	D76	C100	JMK3
12V9-3552	75	2	6	20H6	20	D91	C100	F11
12V9-3553	75	2	6	20H6	20	D126	C100	F11
<b>Ø 100</b>								
12V9-2060	100	2	6	20H6	25	D10	C100	PSQ
12V9-2061	100	2	6	20H6	25	D15	C100	JMK3
12V9-2062	100	2	6	20H6	25	D20	C100	JMK3
12V9-2063	100	2	6	20H6	25	D20	C100	PSQ
12V9-2064	100	2	6	20H6	25	D30	C100	JMK3
12V9-3554	100	2	6	20H6	20	D46	C100	F11
12V9-2065	100	2	6	20H6	25	D46	C100	JMK3
12V9-2066	100	2	6	20H6	25	D64	C100	JMK3
12V9-2067	100	2	6	20H6	25	D76	C100	JMK3
12V9-3555	100	2	6	20H6	25	D91	C100	F11
12V9-3556	100	2	6	20H6	25	D126	C100	F11

# Grinding wheels

12V2

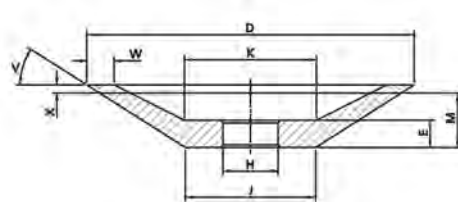

E = 10



Item No	D	V°	W	X	H	T	Grift	Concentration	Bond
<b>Ø 20</b>									
12V2-3539	20	10	2	5	8H6	13	D15	C50	S1
12V2-3381	20	10	2	5	8H6	13	D15	C50	PSE
12V2-3382	20	10	2	5	8H6	13	D25	C75	PSE
12V2-2410	20	10	2	5	8H6	13	D126	C75	PSE
12V2-2411	20	10	2	5	8H6	13	D126	C100	GGs
12V2-3540	20	10	2	5	8H6	13	D126	C100	S1
<b>Ø 25</b>									
12V2-3541	25	10	2	5	8H6	13	D15	C50	S1
12V2-3542	25	10	2	5	8H6	13	D15	C50	PSE
12V2-3543	25	10	2	5	8H6	13	D25	C75	PSE
12V2-2412	25	10	2	5	8H6	16	D126	C75	PSE
12V2-2413	25	10	2	5	8H6	16	D126	C100	GGs
12V2-3544	25	10	2	5	8H6	15 16	D126	C100	S1
<b>Ø 30</b>									
12V2-3383	30	20	2	5	8H6	20	D15	C50	PSE
12V2-3384	30	20	2	5	8H6	20	D25	C75	PSE
12V2-2414	30	20	2	5	8H6	20	D126	C75	PSE
12V2-2415	30	20	2	5	8H6	20	D126	C100	GGs
12V2-3545	30	20	2	5	8H6	20	D126	C100	S1
<b>Ø 20</b>									
12V2-3385	20	10	2	5	8H6	13	B25	C50	PSE
12V2-3386	20	10	2	5	8H6	13	B54	C50	PSE
12V2-2416	20	10	2	5	8H6	13	B126	C50	PSE
12V2-2423	20	10	2	5	8H6	13	B126	C100	PSE
12V2-2417	20	10	2	5	8H6	13	B126	C100	GGs
12V2-3546	20	10	2	5	8H6	13	B126	C100	S1
<b>Ø 25</b>									
12V2-3547	25	10	2	5	8H6	16	B25	C50	S1
12V2-3387	25	10	2	5	8H6	16	B25	C50	PSE
12V2-3388	25	10	2	5	8H6	16	B54	C50	PSE
12V2-2418	25	10	2	5	8H6	16	B126	C50	PSE
12V2-2424	25	10	2	5	8H6	16	B126	C100	PSE
12V2-2419	25	10	2	5	8H6	16	B126	C100	GGs
12V2-3548	25	10	2	5	8H6	25 16	B126	C100	S1
<b>Ø 30</b>									
12V2-3549	30	20	2	5	8H6	20	B25	C50	S1
12V2-3389	30	20	2	5	8H6	20	B126	C50	PSE
12V2-3390	30	20	2	5	8H6	20	B126	C100	GGs
12V2-2420	30	20	2	5	8H6	20	B126	C50	PSE
12V2-2421	30	20	2	5	8H6	20	B126	C100	GGs
12V2-2422	30	20	2	5	8H6	20	B126	C100	PSE
12V2-3550	30	20	2	5	8H6	20	B126	C100	S1

# Grinding wheels

9A3

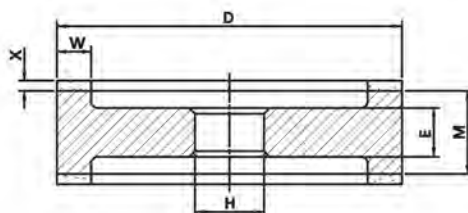
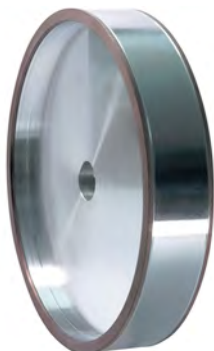

T = M + X  
 D125 E = 10  
 D150 E = 14  
 D175 E = 14



Item No	D	W	X	H	T	Grift	Concentration	Bond
<b>Ø 150</b>								
9A3-1055	150	6	2	16H6	22	D15A	C75	PSEN
9A3-1056	150	6	2	16H6	22	D20	C75	PSE
9A3-1064	150	6	2	16H6	22	D64	C75	GGG
9A3-1057	150	6	2	16H6	22	D91	C75	GGG
9A3-1058	150	6	2	16H6	22	D126	C75	GGG
9A3-3500	150	6	2	16H6	22	D107	C75	bronze
9A3-3397	150	6	2	20H6	25	D7	C30	PSEN
9A3-3398	150	6	2	20H6	25	D10	C75	PSEN
9A3-1059	150	6	2	20H6	25	D15A	C75	PSEN
9A3-1060	150	6	2	20H6	25	D20	C75	PSE
9A3-1063	150	6	2	20H6	25	D64	C75	GGG
9A3-1061	150	6	2	20H6	25	D91	C75	GGG
9A3-1062	150	6	2	20H6	25	D126	C75	GGG
9A3-3399	150	6	2	20H6	25	D107	C75	bronze
<b>Ø 175</b>								
9A3-3391	175	6	2	20H6	33	D7	C30	PSEN
9A3-3392	175	6	2	20H6	33	D10	C75	PSEN
9A3-439	175	6	2	20H6	33	D15A	C75	PSEN
9A3-440	175	6	2	20H6	33	D20	C75	PSE
9A3-441	175	6	2	20H6	33	D30	C75	PSE
9A3-442	175	6	2	20H6	33	D46	C75	GGG
9A3-443	175	6	2	20H6	33	D64	C75	GGG
9A3-906	175	6	2	20H6	33	D76	C75	GGG
9A3-447	175	6	2	20H6	33	D91	C75	GGG
9A3-436	175	6	2	20H6	33	D126	C75	GGG
9A3-448	175	6	2	20H6	33	D107	C75	GGG
9A3-3396	175	6	2	20H6	33	D107	C75	bronze
9A3-3393	175	6	2	20H6	25	D7	C30	PSEN
9A3-3394	175	6	2	20H6	25	D10	C75	PSEN
9A3-438	175	6	2	20H6	25	D15A	C75	PSEN
9A3-449	175	6	2	20H6	25	D20	C75	PSE
9A3-450	175	6	2	20H6	25	D64	C75	GGG
9A3-840	175	6	2	20H6	25	D76	C75	GGG
9A3-490	175	6	2	20H6	25	D91	C75	GGG
9A3-754	175	6	2	20H6	25	D126	C75	GGG
9A3-3395	175	6	2	20H6	25	D107	C75	bronze

# Grinding wheels

## Diamond Pin wheels 1A1W with carbide shank

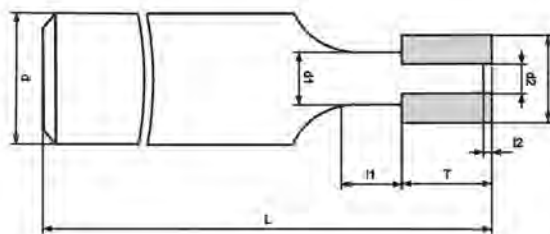

Item No	D	T	d2	l2	d1	l1	d	L	Grift	Concentration	Bond
<b>Ø 0.3</b>											
1A1W-100	0.3	1	0.2	0.1	0.3	1	3	45	D15	100	PSER
1A1W-101	0.3								D46	150	MDG
1A1W-102	0.3								B15	100	PSER
1A1W-103	0.3								B46	150	MDB
<b>Ø 0.4</b>											
1A1W-104	0.4	1	0.2	0.1	0.3	2	3	45	D15	100	PSER
1A1W-105	0.4								D46	150	MDG
1A1W-106	0.4								B15	100	PSER
1A1W-107	0.4								B46	150	MDB
<b>Ø 0.5</b>											
1A1W-108	0.5	1.5	0.3	0.1	0.4	2	3	45	D15	100	PSER
1A1W-109	0.5								D46	150	MDG
1A1W-110	0.5								B15	100	PSER
1A1W-111	0.5								B46	150	MDB
<b>Ø 0.6</b>											
1A1W-112	0.6	2	0.3	0.1	0.5	2	3	45	D15	100	PSER
1A1W-113	0.6								D46	150	MDG
1A1W-114	0.6								B15	100	PSER
1A1W-115	0.6								B64	150	MDB
<b>Ø 0.7</b>											
1A1W-116	0.7	2	0.4	0.1	0.6	2	3	45	D15	100	PSER
1A1W-117	0.7								D46	150	MDG
1A1W-118	0.7								B15	100	PSER
1A1W-119	0.7								B64	150	MDB
<b>Ø 0.8</b>											
1A1W-120	0.8	2.5	0.4	0.1	0.6	3	3	45	D15	100	PSER
1A1W-121	0.8								D46	150	MDG
1A1W-122	0.8								B15	100	PSER
1A1W-123	0.8								B76	150	MDB
<b>Ø 0.9</b>											
1A1W-124	0.9	2.5	0.5	0.1	0.7	3	3	45	D15	100	PSER
1A1W-125	0.9								D46	150	MDG
1A1W-126	0.9								B15	100	PSER
1A1W-127	0.9								B76	150	MDB
<b>Ø 1</b>											
1A1W-128	1	2.5	0.6	0.1	0.8	3	3	45	D15	100	PSER
1A1W-129	1								D46	150	MDG
1A1W-130	1								B15	100	PSER
1A1W-131	1								B91	150	MDB
<b>Ø 1.2</b>											
1A1W-132	1.2	3	0.7	0.2	0.9	3	3	45	D46	100	PSER
1A1W-133	1.2								D64	150	MDG

# Grinding wheels

Diamond Pin wheels 1A1W with carbide shank

continuation...

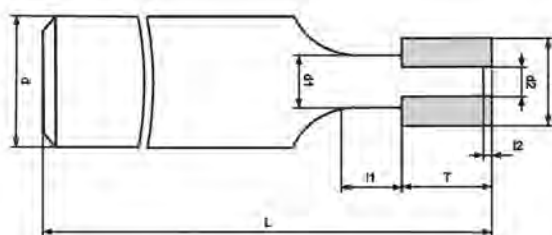

Item No	D	T	d2	l2	d1	l1	d	L	Grift	Concentration	Bond
<b>Ø 1.2</b>											
1A1W-134	1.2								D76	100	PSER
1A1W-135	1.2								D91	150	MDB
<b>Ø 1.5</b>											
1A1W-136	1.5	3	0.9	0.2	1.1	4	3	45	D15	100	PSER
1A1W-137	1.5								D46	150	MDG
1A1W-138	1.5								D91	150	MDG
1A1W-139	1.5								B15	100	PSER
1A1W-140	1.5								B64	150	MDB
1A1W-141	1.5								B151	150	MDB
<b>Ø 1.8</b>											
1A1W-142	1.8	4	1.1	0.2	1.4	4	3	45	D15	100	PSER
1A1W-143	1.8								D46	150	MDG
1A1W-144	1.8								D91	150	MDG
1A1W-145	1.8								B15	100	PSER
1A1W-146	1.8								B64	150	MDB
1A1W-147	1.8								B151	150	MDB
<b>Ø 2</b>											
1A1W-148	2	4	1.2	0.2	1.5	4	3	45	D15	100	PSER
1A1W-149	2								D46	100	MDG
1A1W-150	2								D76	150	MDG
1A1W-151	2								D126	150	MDG
1A1W-152	2								B15	100	PSER
1A1W-153	2								B64	150	MDB
1A1W-154	2								B151	150	MDB
<b>Ø 2.2</b>											
1A1W-155	2.2	5	1.3	0.3	1.8	5	3	45	D15	100	PSER
1A1W-156	2.2								D46	100	MDG
1A1W-157	2.2								D76	150	MDG
1A1W-158	2.2								D126	150	MDG
1A1W-159	2.2								B15	100	PSER
1A1W-160	2.2								B64	150	MDB
1A1W-161	2.2								B151	150	MDB
<b>Ø 2.5</b>											
1A1W-162	2.5	5	1.4	0.3	2.1	5.5	3	45	D15	100	PSER
1A1W-163	2.5								D46	100	MDG
1A1W-164	2.5								D76	150	MDG
1A1W-165	2.5								D126	150	MDG
1A1W-166	2.5								B15	100	PSER
1A1W-167	2.5								B64	150	MDB
1A1W-168	2.5								B151	150	MDB
<b>Ø 2.8</b>											
1A1W-169	2.8	5.5	1.6	0.3	2.2	16	3	45	D15	100	PSER
1A1W-170	2.8								D46	150	MDG
1A1W-171	2.8								D76	150	MDG

# Grinding wheels

Diamond Pin wheels 1A1W with carbide shank

continuation...

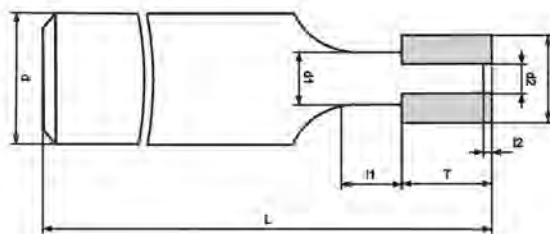

Item No	D	T	d2	l2	d1	l1	d	L	Grift	Concentration	Bond
<b>Ø 2.8</b>											
1A1W-172	2.8								D126	150	MDG
1A1W-173	2.8								B15	100	PSER
1A1W-174	2.8								B64	150	MDB
1A1W-175	2.8								B151	150	MDB
<b>Ø 3</b>											
1A1W-176	3	6	1.8	0.3	2.2	6	3	45	D15	100	PSER
1A1W-177	3								D46	150	MDG
1A1W-178	3								D76	150	MDG
1A1W-179	3								D126	150	MDG
1A1W-180	3								B15	100	PSER
1A1W-181	3								B64	150	MDB
1A1W-182	3								B151	150	MDB
<b>Ø 3.5</b>											
1A1W-183	3.5	6	2	0.3	2.8	6	3	60	D15	100	PSER
1A1W-184	3.5								D46	150	MDG
1A1W-185	3.5								D76	150	MDG
1A1W-186	3.5								D126	150	MDG
1A1W-187	3.5								B15	100	PSER
1A1W-188	3.5								B64	150	MDB
1A1W-189	3.5								B151	150	MDB
<b>Ø 4</b>											
1A1W-190	4	6	2.4	0.5	3		3	60	D15	100	PSER
1A1W-191	4								D46	150	MDG
1A1W-192	4								D91	150	MDG
1A1W-193	4								D151	150	MDG
1A1W-194	4								B15	100	PSER
1A1W-195	4								B64	150	MDB
1A1W-196	4								B151	150	MDB
<b>Ø 4.5</b>											
1A1W-197	4.5	6	2.7	0.5	3		3	60	D15	100	PSER
1A1W-198	4.5								D46	150	MDG
1A1W-199	4.5								D91	150	MDG
1A1W-200	4.5								D151	150	MDG
1A1W-201	4.5								B15	100	PSER
1A1W-202	4.5								B64	150	MDB
1A1W-203	4.5								B151	150	MDB
<b>Ø 5</b>											
1A1W-204	5	6	3	0.5	3		3	60	D15	100	PSER
1A1W-205	5								D46	150	MDG
1A1W-206	5								D91	150	MDG
1A1W-207	5	6	3	0.5	3		3	60	D151	100	PSER
1A1W-208	5								B15	100	PSER
1A1W-209	5								B64	150	MDB
1A1W-210	5								B151	150	MDB

# Grinding wheels

Diamond Pin wheels 1A1W with carbide shank

continuation...

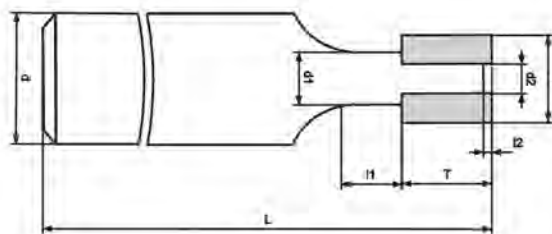

Item No	D	T	d2	l2	d1	d	L	Grift	Concentration	Bond
<b>Ø 5.5</b>										
1A1W-211	5.5	6	3	0.5	3	3	60	D15	100	PSER
1A1W-212	5.5							D46	150	MDG
1A1W-213	5.5							D91	150	MDG
1A1W-214	5.5							D151	150	MDG
1A1W-215	5.5							B15	100	PSER
1A1W-216	5.5							B64	150	MDB
1A1W-217	5.5							B151	150	MDB
<b>Ø 6</b>										
1A1W-218	6	7	4	0.5	4	4	60	D15	100	PSER
1A1W-219	6							D46	150	MDG
1A1W-220	6							D91	150	MDG
1A1W-221	6							D151	150	MDG
1A1W-222	6							B15	100	PSER
1A1W-223	6							B64	150	MDB
1A1W-224	6							B151	150	MDB

# Grinding wheels

## Diamond Pin wheels 1A1W with hardened steel shank

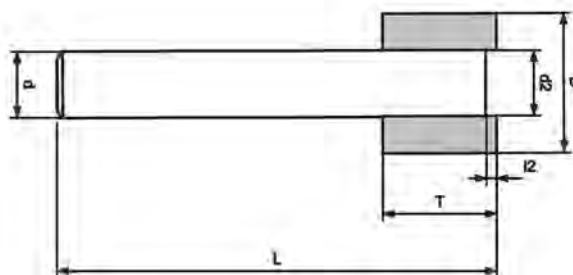

Item No	D	T	d2	l2	X	d1	l1	d	L	Grift	Concentration	Bond
<b>Ø 6.5</b>												
1A1W-225	6.5	7	4	0.5		5	8	6	80	D15	100	PSER
1A1W-226	6.5									D46	150	MDG
1A1W-227	6.5									D91	150	MDG
1A1W-228	6.5									D151	150	MDG
1A1W-229	6.5									B15	100	PSER
1A1W-230	6.5									B64	150	MDB
1A1W-231	6.5									B151	150	MDB
<b>Ø 7</b>												
1A1W-232	7	7			2	5	8	6	80	D15	100	PSER
1A1W-233	7				1.5					D64	150	MDG
1A1W-234	7				1.5					D126	150	MDG
1A1W-235	7				2					B15	150	PSER
1A1W-236	7				1.5					B64	100	MDB
1A1W-237	7				1.5					B151	150	MDB
<b>Ø 8</b>												
1A1W-238	8	8			2			6	80	D15	100	PSER
1A1W-239	8				1.5					D64	150	MDG
1A1W-240	8				1.5					D126	150	MDG
1A1W-241	8				2					B15	100	PSER
1A1W-242	8				1.5					B64	150	MDB
1A1W-243	8				1.5					B151	150	MDB
<b>Ø 9</b>												
1A1W-244	9	10			2			6	80	D15	100	PSER
1A1W-245	9				1.5					D64	150	MDG
1A1W-246	9				1.5					D126	150	MDG
1A1W-247	9				2					B15	100	PSER
1A1W-248	9				1.5					B64	150	MDB
1A1W-249	9				1.5					B151	150	MDB
<b>Ø 10</b>												
1A1W-250	10	10			2					D15	100	PSER
1A1W-251	10	10			1.5					D64	150	MDG
1A1W-252	10	10			1.5					D126	150	MDG
1A1W-253	10	10			2					B15	100	PSER
1A1W-254	10	10			1.5					B64	150	MDB
1A1W-255	10	10			1.5					B151	150	MDB
<b>Ø 12</b>												
1A1W-256	12	10			2			6	80	D15	100	PSER
1A1W-257	12	10			1.5					D64	150	MDG
1A1W-258	12	10			1.5					D126	150	MDG
1A1W-259	12	10			2					B15	100	PSER
1A1W-260	12	10			1.5					B64	150	MDB
1A1W-261	12	10			1.5					B151	150	MDB

# Grinding wheels

Diamond Pin wheels 1A1W with hardened steel shank

continuation...

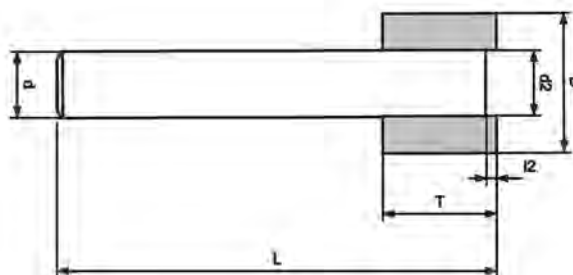

Item No	D	T	X	d	L	Grift	Concentration	Bond
<b>Ø 15</b>								
1A1W-262	15	10	2	10	80	D15	100	PSER
1A1W-263	15	10	1.5			D64	150	MDG
1A1W-264	15	10	1.5			D126	150	MDG
1A1W-265	15	10	2			B15	100	PSER
1A1W-266	15	10	1.5			B64	150	MDB
1A1W-267	15	10	1.5			B151	150	MDB
<b>Ø 20</b>								
1A1W-268	20	10	2	10	80	D15	100	PSER
1A1W-269	20	10	1.5			D64	150	MDG
1A1W-270	20	10	1.5			D126	150	MDG
1A1W-271	20	10	2			B15	100	PSER
1A1W-272	20	10	1.5			B64	150	MDB
1A1W-273	20	10	1.5			B151	150	MDB

# Diamond paste and stones for cleaning

## Diamond paste



Diamond paste of high quality, Strong concentration, miscible with oil



Item No	Diamond	Micron	Colour
PD001-1018	1/10	$\mu$ 0-0.25	dark grey
PD014-1019	1/4	$\mu$ 0-0.5	grey
PD012-1020	1/2	$\mu$ 0-1	light grey
PD010-1021	1	$\mu$ 0-2	ivory
PD030-1022	3	$\mu$ 2-4	yellow
PD060-1023	6	$\mu$ 4-8	orange
PD090-1024	9	$\mu$ 8-12	green
PD120-1025	12	$\mu$ 9-15	blue-green
PD150-1026	15	$\mu$ 12-22	blue
PD200-1027	20	$\mu$ 15-25	light brown
PD250-1028	25	$\mu$ 20-30	light yellow
PD300-1029	30	$\mu$ 22-36	red
PD450-1030	45	$\mu$ 36-54	brown
PD500-1031	50	$\mu$ 40-60	pink
PD600-1032	60	$\mu$ 54-80	purple
PD900-1033	90	$\mu$ 80-100	black

SF15-5 Guide bushes Diamond paste

# Diamond paste and stones for cleaning

## Stones for cleaning



Item No	Stones for cleaning of coundum
Pierre-1048	AR (rough)
Pierre-1049	AR (finish)

# Accessories for wheels

## Flanges for wheels H=20

Réf. 1050 : pour meule  
für Scheiben / for wheel

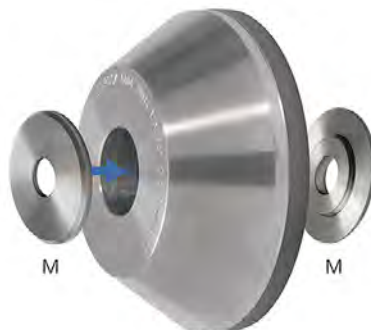

Item No	Flange for wheels H=20
Entretoise-1050	H=20=> H=10 AR 35x5x10H6 (2x Type M)

## Flanges for disks H=20



Réf. 1047 : pour disque  
für Trennscheiben / for disc



Item No	Flange for disc H=20
Entretoise-1047	H=20 => H=10 : 35x5x10H6 (1x Type F + 1x Type M)

# Accessories for wheels

## Flanges for antivibration disc



Item No	Flange for antivibration
Entretoise-1052	D45 d=20H6 T=3.5 (2x Type F)
Entretoise-1054	D65 d=20H6 T=3.5 (2x Type F)
Entretoise-1056	D65 d=10H6 T=3.5 (2x Type F)

## Stakes out of steel for catch out of grip



Item No	Stakes out of steel for catch out of grip
AR THO 1	Ø = 8 mm shaft 6x40 mm, total length = 50 mm
AR THO 2	Ø = 10 mm shaft 6x40 mm, total length = 50 mm
AR THO 3	Ø = 6 mm shaft 6x40 mm, total length = 50 mm
AR CASY1	Synthetic bush Ø int. = 6 mm / Ø ext. = 10 mm